

**APPLICATIONS AND EXPERIENCES WITH SUPER DUPLEX  
STAINLESS STEEL IN WET FGD SCRUBBER SYSTEMS.**

**R. Francis, G Byrne, G Warburton and S Hebdon  
Weir Materials Limited  
Park Works  
Newton Heath  
Manchester  
M40 2BA**

**ABSTRACT**

The paper presents the properties of the author's company's proprietary super duplex stainless steel. Work is presented showing the development of a more realistic laboratory solution representing typical limestone slurries found in real flue gas desulphurisation (FGD) systems. The importance of additions of metal ions such as  $\text{Fe}^{3+}$  and  $\text{Mn}^{2+}$  as well as partially oxidised sulphur species is demonstrated. Results are presented comparing the crevice corrosion resistance of super duplex stainless steel in these slurries with other commonly used wrought and cast stainless steels, for both simulated anthracite and lignite type slurries. Data from loop tests on the erosion resistance of a range of alloys in simulated FGD slurries is presented. The results clearly show the superior resistance of super duplex stainless steel to both crevice corrosion and erosion in FGD slurries. Finally the experiences in UK FGD systems with both cast and wrought super duplex stainless steel are presented.

**INTRODUCTION**

Flue Gas Desulphurisation (FGD) is used to remove sulphur containing gases (mostly sulphur dioxide) from the flue gas discharges of coal fired power stations. The most common method for doing this is the wet limestone process, where a slurry of crushed limestone and water is passed down an absorber tower as the flue gases rise up. The limestone is converted to gypsum (calcium sulphate) which is periodically removed and fresh limestone is added. Because of the recirculation method and the wish to minimise water additions, the dissolved solids content of the slurry is often high, depending on the nature of the coal being burnt and the composition of the make up water. Chlorides, in particular, can be very high; 40,000mg/l is not uncommon, but the sulphate content is also high. During operation the temperature can be in the range 45<sup>o</sup> to 70<sup>o</sup>C and the pH is generally from 4 to 6, depending on the type of coal being burnt.

**Copyright**

Figure 1 shows a schematic diagram of a typical FGD absorber tower. This shows some of the areas where either corrosion resistant alloy components or rubber lined steel are used eg absorber tower walls, slurry recirculation pumps.

There are two principal types of coal burned in power stations and these give rise to somewhat different slurry compositions.

Anthracite or hard coal is generally low in fluorides, but, at least in the UK, the chloride level is high. This gives rise to a slurry with the following characteristics :

Chloride	-	20 to 40 g/l
Fluoride	-	~ 50 mg/l
Temperature	-	45 <sup>o</sup> to 50 <sup>o</sup> C
pH	-	4.5 - 5.5

Lignite or brown coal is generally higher in fluorides, although most of these will be insoluble CaF<sub>2</sub>, and only soluble fluorides will influence corrosion. Chlorides in lignite fuels are usually lower than with anthracite, while operating temperatures are higher. Typical lignite slurry characteristics are as follows :

Chloride	-	5 to 15 g/l
Fluoride	-	100 to 200 mg/l
Temperature	-	60 <sup>o</sup> to 70 <sup>o</sup> C
pH	-	4.5 to 6

When sulphur dioxide is oxidised to gypsum the overall reaction is :

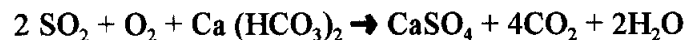

However, the oxidation of sulphur dioxide does not occur in a single step and there are a number of intermediate stages. These result in the formation of partially oxidised sulphur species such as sulphite (SO<sub>3</sub><sup>2-</sup>), thiosulphate (S<sub>2</sub>O<sub>3</sub><sup>2-</sup>), dithionate (S<sub>2</sub>O<sub>6</sub><sup>2-</sup>) and possibly others.

Sulphites react rapidly with oxygen to form sulphate, and are generally thought to have no significant effect on the corrosion of stainless steels in aerated solutions. Thiosulphate has been shown to affect the resistance of 304 and 316 stainless steels to pitting at elevated temperatures in acid brines (1). There is nothing published on the effect of dithionate on the pitting of stainless steels.

In addition to partially oxidised sulphur species, real FGD slurries also contain significant quantities of metal ions such as Fe<sup>3+</sup>, Al<sup>3+</sup> and Mn<sup>2+</sup>. There are also halides present such as the fluorides and chlorides discussed above and bromides as well. All of these species can affect the corrosion behaviour and it is important that they are present in laboratory test slurries.

## DEVELOPMENT OF TEST SOLUTION

Early laboratory tests (2) were conducted in simple solutions of calcium chloride and sulphate and a more realistic slurry was devised for the present corrosion tests.

A synthetic anthracite-type slurry based on UK coal was devised as shown below :

CaSO <sub>4</sub>	-	100g/l	
CaCl <sub>2</sub> · 6H <sub>2</sub> O	-	117g/l	(38,000mg/l Cl <sup>-</sup> )
NaCl	-	3.3g/l	(2,000mg/l Cl <sup>-</sup> )
Fe <sub>2</sub> (SO <sub>4</sub> ) <sub>3</sub>	-	0.07g/l	(10mg/l Fe <sup>3+</sup> )
Na F	-	0.155g/l	(70mg/l F <sup>-</sup> )
Na Br	-	0.644g/l	(500 mg/l Br <sup>-</sup> )
Al <sub>2</sub> (SO <sub>4</sub> ) <sub>3</sub> · 16H <sub>2</sub> O	-	0.35/l	(30mg/l Al <sup>3+</sup> )

There are two other additions which were required, manganese and partially oxidised sulphur species. Dithionate salts are not generally available off the shelf and so they were produced in the laboratory. 5 grammes of manganese dioxide was added to 1 litre of distilled water and sulphur dioxide was bubbled through the solution for five minutes. All the manganese dioxide had then reacted. This was demonstrated by filtering the solution through a micropore filter, and nothing was retained on the filter. Subsequent production of dithionate omitted the filtration. The solution was heated to 40° to 50°C for several hours to drive off excess SO<sub>2</sub>. Although this reaction produces principally manganese dithionate,

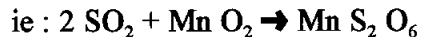

there will also be some other partially oxidised sulphur species, such as thiosulphate. Whilst the concentration is not known, the sulphur species were produced in a similar way to that in which they are generated in FGD absorbers and so the laboratory solution was felt to represent service environments reasonably well. Dithionate concentrations in real slurries are not thought to exceed 200mg/l normally.

A concentration of 200mg/l dithionate contained 69mg/l manganese, while a typical slurry would normally contain some 20 to 50 mg/l manganese. With 1500mg/l dithionate, the manganese content rose to 516mg/l. Tests were conducted without dithionate, but with different concentrations of manganese, added as the chloride, and these gave no significant change in crevice corrosion resistance up to 600mg/l Mn<sup>2+</sup>. Hence the presence of additions of manganese above normal did not significantly contribute to crevice corrosion.

The pH of the test solution was adjusted with caustic soda or dilute sulphuric acid as required. The pH of the test solutions was not stable but drifted with time. High "dithionate" solutions tended to drift acidic, while low "dithionate" solutions tended to drift to higher pH. The pH was readjusted over a period of 24 hours until the rate of change was slow. The pH before and after each test was measured. Typically the pH drifted by 0.3 to 0.6 pH units during a test. The nominal pH was set in the middle of this range.

The simulated lignite slurry was made as follows :

CaSO <sub>4</sub>	-	100g/l	
CaCl <sub>2</sub> . 6H <sub>2</sub> O	-	40g/l	(13,000mg/l Cl <sup>-</sup> )
NaCl	-	3.3g/l	(2,000mg/l Cl <sup>-</sup> )
Fe <sub>2</sub> (SO <sub>4</sub> ) <sub>3</sub>	-	0.07g/l	(10mg/l Fe <sup>3+</sup> )
Na F	-	0.442g/l	(200mg/l F <sup>-</sup> )
Na Br	-	0.644g/l	(500 mg/l Br <sup>-</sup> )
Al <sub>2</sub> (SO <sub>4</sub> ) <sub>3</sub> . 16H <sub>2</sub> O	-	0.35g/l	(30mg/l Al <sup>3+</sup> )

The two differences between this and the anthracite type slurry are the reduced chloride content and the increased fluoride content. The “dithionate” was added in the same manner as before and the pH adjustments were also made as above.

Compressed air was bubbled continuously through all the test solutions during testing.

### DEVELOPMENT OF THE TEST METHOD

The test pieces took the form of 10mm diameter cylinders, 30mm long with a hemispherical end. The flat end face was drilled and tapped to 6BA for attachment to a holder. Prior to testing, the bullet samples were ground down to 1200 grit and duramastic lacquer was applied to the flat end face to prevent corrosion under the seal. A crevice was created around the bullet with a 7mm id x 2mm thick neoprene ‘O’ ring. The bullet was sealed to a glass holder with a PTFE seal as shown in Figure 2.

The initial test method was to use a reference electrode of the same material as the one on test. This was because no information was available on electrode potentials in FGD slurries. The electrodes were placed in standard glass reaction vessel of 750ml capacity, filled with slurry. The electrodes were allowed to stabilise for 15 to 20 minutes and then the test electrode was polarised to 100 mV positive with respect to the reference electrode over a period of 30 minutes. The current was allowed to stabilise for a further hour and then the temperature was slowly increased at 5°C/hour up to about 80°C, where it was held constant for a further 3 hours.

After polarisation to the test potential the current density dropped rapidly and stabilised at a value much less than 1µA/cm<sup>2</sup>. When crevice corrosion initiated the current density increased rapidly, and crevice corrosion was said to have initiated when the current density exceeded 10µA/cm<sup>2</sup>. This value is somewhat arbitrary but has been in use for many years by a variety of laboratories since the original work of Oldfield and Sutton (3). The temperature at which crevice corrosion initiates is known as the critical crevice temperature (CCT).

The first tests were conducted with a matching, metallic reference electrode as described above. However, the results were erratic with the critical crevice temperature (CCT) varying from 47°C to >77°C under the same conditions. Numerous changes were made to the sample preparation and solution preparation to try and eliminate this behaviour. No simple remedy to the irreproducibility of the results was found. It was thought that the results could be due to fluctuations in the potential

of the reference electrode, and so tests were conducted to measure the rest potential with time.

### Potential Monitoring

Quickly it became apparent that there were two types of potential / time response with super duplex stainless steel. This was the same whether the material was cast or wrought. The two types are shown in figures 3 and 4. The data in figure 3 clearly shows a rapid rise in potential which then fluctuated somewhat around +300mV SCE. However, other samples behaved like that shown in figure 4, where there was a much smaller initial increase in potential, followed by a steady rise over a long period to around the same value as shown in figure 3. Several changes were made to the solution composition, eg replace the calcium salts with sodium ones, and also to the pH and temperature (ie constant or gradually increasing).

In addition all specimens were allowed to stand in dry air for 24 hours after preparation to ensure a robust air-formed oxide surface film was produced. None of these changes produced any significant alteration in the potential response with time and variations of the responses shown in figures 3 and 4 were produced, often on supposedly duplicate samples.

The stable potentials in figures 3 and 4 are about +350mV SCE. Throughout the total number of potential tests conducted (16 in all), the final potential varied from about +200mV SCE to about +350mV SCE. These results suggest that +300mV SCE represents a typical stable potential for super duplex stainless steel in FGD slurries containing partially oxidised sulphur species.

The results explain the erratic behaviour when using a metal reference electrode. Samples with a reference electrode which quickly achieved 300mV SCE would be polarised to +400mV SCE whilst samples with a reference electrode that was only at, say, +150mV SCE would be polarised to only +250mV SCE. Obviously the more positive the potential, the greater the susceptibility to crevice corrosion.

It is possible that the relatively high stable potential of ~300mV SCE is due to the presence of oxidising metal ions, particularly  $Fe^{3+}$ . These increase the redox potential in other solutions producing high potentials and the same result would be expected in the present solutions. The reason for the varying time response is not clear, but may well be due to the presence of sulphur species in various states of oxidation in solution. Somewhat variable sulphur-containing films have been produced during electrochemical tests of stainless steels in sour brines at elevated temperature (4), and something similar may be happening here.

The results suggested that polarising to +300mV SCE from the start of the tests would be a reasonable representation of the potential seen in service. The response of all high alloy stainless steels such as super duplex and super austenitic, to the simulated FGD slurries has been assumed to be the same, and tests on all the alloys were conducted at +300mV SCE.

A typical current density versus time plot is shown in figure 5, with the temperature added for clarity.

## MATERIALS

Zeron 100® is a duplex stainless steel with a composition producing a microstructure which is 50% ferrite and 50% austenite. This combines the properties of strength and ductility. The alloy is available in both cast and wrought product forms, and the nominal compositions are shown in Table 1, with those of other commonly used stainless steels for comparison.

The high levels of chromium, molybdenum and nitrogen in the alloy give it excellent resistance to localised corrosion in chloride containing fluids. The copper and tungsten content give the alloy resistance to acids, particularly mineral acids such as sulphuric and hydrochloric acids.

An indication of the resistance to pitting in chloride solutions is given by the Pitting Resistance Equivalent Number (PREN) which is an empirical relationship linking the chromium, molybdenum and nitrogen contents of corrosion resistant alloys.

$$\text{PREN} = \% \text{ Cr} + 3.3 \times \% \text{ Mo} + 16 \times \% \text{ N}$$

Common austenitic alloys such as 316L have a PREN of 24, while 22Cr duplex has a PREN of 34. The author's Company's proprietary alloy has a guaranteed minimum PREN of 40, and is the only alloy to guarantee a minimum PREN value.

The minimum mechanical properties of the author's Company's proprietary alloy are shown in Table 2, with those of austenitic alloys such as 316L and 6Mo austenitic for comparison. It can be seen that the proof stress of the author's Company's proprietary alloy is more than 2.5 times that of 316L and 1.8 times that of 6Mo. The high strength means that substantial reductions in wall thickness can be obtained, particularly in high temperature / high pressure applications. In addition to savings in the cost of parent material, this also results in savings in fabrication costs and time.

The useful operating range for the author's Company's proprietary alloy is the same as for other duplex alloys, ie -50°C to +300°C. At temperatures lower than -50°C there is a decrease in impact toughness. At temperatures above 300°C the alloy slowly becomes embrittled due to the precipitation of a third phase (alpha prime).

The author's Company's proprietary alloy is readily welded, by most of the common processes ie TIG (GTAW), MMA (SMAW), SAW etc. For as-welded use it is fabricated with overalloyed Zeron 100X consumables, which have a higher nickel content to ensure the correct phase balance in the weld metal. Material thicknesses from 1.6mm to 63mm have been welded successfully and it is estimated that about one million welds are now in service around the world.

® Trademark of Weir Materials Limited

The test bullets were machined from commercially produced products as follows :

Wrought super duplex	-	½" diameter bar
Cast duplex / super duplex	-	solution annealed test bars
6 Mo austenitic	-	NPS 6 Schedule 80S pipe

Welded samples were cut from GTA welded 4mm plate with dimensions of 50mm x 13mm, with the weld bead between the long edges. A super duplex welding wire was tack welded to a short edge to provide electrical connection. This edge and the welding wire were masked with duramastic lacquer. Welds in service would not normally be creviced and the risk is of pitting corrosion of the welds / HAZ. Hence the tests on the welded coupons had no crevice former.

## RESULTS

During normal operation of an FGD plant the pH generally varies from 4.5 to 6.0, but under adverse conditions pH values as low as 4 are possible. Initially the effect of pH in the new slurry was studied, as previous work in simple chloride / sulphate solutions (2) found that the CCT was unaffected by pH over the range 2 to 6.

All the tests contained 200 mg/l "dithionate" and the results for cast and wrought super duplex are shown in figures 6 and 7 for a simulated anthracite slurry. The cast material clearly shows the effect of pH, with a reduction in CCT of ~10°C for each pH unit decrease in pH. However, the wrought alloy shows no such decrease in CCT with decreasing pH. The reasons for this difference are not clear, but may be connected with local inhomogeneity in the cast material. This difference between the wrought and cast forms requires further study.

With items such as super duplex pumps the greatest risk of crevice corrosion is between the shaft and the seals / wear rings. As these are usually in wrought super duplex, the risk of crevice corrosion during normal operation is extremely low. However, during shutdown slurry deposits may settle on cast surfaces such as the casing or impellers and remain wet. The pH beneath these deposits could then decrease to ~pH 3 and crevice corrosion might occur. It is clearly advisable to wash out pumps with fresh water prior to shutdown.

As stated above, pH 4 represents a worst case pH for operational conditions and a series of tests on different alloys was conducted at this pH.

Table 3 shows the results of CCT tests in a simulated anthracite slurry at pH 4. In this environment normal operating temperatures are about 50°C. The results show that wrought super duplex is superior to the 6Mo wrought alloy, while the older cast 25Cr duplex is unsuitable for this environment. Welded and cast super duplex are also suitable in this application.

Table 4 shows the CCT data for a simulated lignite slurry, where operating temperatures are typically 60°C - 65°C. Once again wrought super duplex is clearly superior to the 6Mo austenitic alloy. Cast and welded super duplex are also suitable, but the older 25Cr duplex alloy is not.

Although 6Mo austenitic welds were not tested in this programme, it is expected that the critical pitting temperature (CPT) would show a similar decrease compared with parent metal as did the super duplex. This is because of segregation in the weld metal and the reduced corrosion resistance of the unmixed zone (5).

These results show the excellent resistance of the author's Company's proprietary alloy to crevice corrosion, particularly the wrought product.

## EROSION CORROSION

The calcium sulphate and limestone in FGD slurries are not particularly erosive, and it is the fly ash which causes most of the erosion.

Tests have been conducted in simulated FGD brines including fly ash in a recirculating erosion test rig (6). Results from pin erosion tests showed that the author's Company's proprietary alloy offered superior erosion resistance to austenitic alloys such as 316L as well as more highly alloyed materials. Figure 8 shows the erosion resistance of several alloys including super duplex, as a function of pH. It can be seen that the author's Company's proprietary alloy has the best erosion resistance, which is not affected by pH ie the alloy does not corrode at low pH.

Following these promising results a test loop was constructed utilising a super duplex pump and pipework and handling the same slurry (6). After 3000 hours running, the pump and pipework were in excellent condition, with some etching of the material at the vane tips (ie the region of greatest velocity). Polishing of the impeller vanes by the slurry actually increased the pump efficiency with increasing running time.

## APPLICATIONS AND EXPERIENCES

The excellent corrosion resistance of the author's Company's proprietary alloy combined with its high strength make it suitable for a wide range of applications in FGD plant.

Cast super duplex can be used for pumps, valves and agitators, while the wrought product can be used for ducting, where acid condensation may occur, up to 300°C. Other applications include gas distribution plates, sprinkler heads, fasteners, centrifuges and absorber tower linings. With absorber towers the high strength of super duplex stainless steel means it may be more economic to make absorber vessels from solid alloy rather than clad steel (7). One power station in the USA has changed from clad to solid super duplex for absorber vessels because of the economics (7).

The author's Company's proprietary alloy has been used successfully for the slurry pumps, agitator stools and the gas distribution plates at the Drax FGD plant in the UK. After up to two years in operation there is no significant erosion of any of the Zeron 100 components.



The slurry centrifuges at Ratcliffe FGD plant in the UK were supplied in the author's Company's proprietary alloy and after two years operation they are in excellent condition. After a short time of operation the glass fibre-reinforced plastic slurry return lines at Ratcliffe FGD plant were suffering severe erosion. These have now been replaced with spools in the author's Company's proprietary alloy and have given no further problems.

## CONCLUSIONS

1. The behaviour of super duplex stainless steel is very different in a simulated FGD slurry to a simple chloride / sulphate solution.
2. The potential of super duplex stainless steel in a simulated FGD slurry is about +300mV SCE but it can take 24 hours or more to reach this value.
3. There is no significant change in the resistance to crevice corrosion of wrought super duplex from pH 3 to 5 in a simulated FGD solution.
4. The critical crevice corrosion temperature for cast super duplex increases by  $\sim 10^{\circ}\text{C}$  per pH unit from pH3 to pH5 in a simulated FGD solution.
5. Wrought super duplex has a superior crevice corrosion resistance compared with a 6Mo austenitic alloy in both simulated anthracite and lignite FGD slurries at pH4.
6. Cast super duplex is suitable for use in both simulated anthracite and lignite slurries down to pH4, while older, lower alloy 25Cr alloys are not.

## REFERENCES

1. R Newman, W P Wong, H Ezuber and A Garner  
Corrosion 45, (1989) 282
2. J P Audouard, P Soullignac and F Dupoirion  
Materials Selection for Wet FGD Systems  
Presented at "Airpol '90", Louisville, USA Oct 1990
3. J W Oldfield and W H Sutton  
Brit. Corr J 13 (1978) 13  
13 (1978) 104
4. R D Kane and M J Schofield  
Safe Use Limits for Stainless Steels in Production of Oil and Gas containing  $\text{H}_2\text{S}$  and  $\text{CO}_2$   
Final Report for Multiclient Sponsor Group Jan 1995

5. **T G Gooch**  
**Stainless Steel World 7 Nov (1995) page 29.**
6. **J T Dallas and T A McConnell**  
**“Solids Pumping” Seminar organised by I Mech E London, UK Oct 1991, page 9**
7. **K Bendall, Paper 448**  
**Corrosion '96, Denver, USA, March 1996. NACE**

# TABLE 1 Nominal composition of some common stainless steels

FORM	ALLOY	Composition (wt%)							PREN*
		Fe	Cr	Ni	Mo	N	Cu	W	
Wrought	Z100	bal	25	7	3.5	0.25	0.7	0.7	> 40
	6Mo Aust.	bal	20	18	6	0.2	0.7	-	43
	22Cr Duplex	bal	22	5	3	0.15	-	-	34
	316L	bal	17	10	2	-	-	-	24
Cast	Z100	bal	25	8	3.5	0.25	0.7	0.7	> 40
	25Cr Duplex	bal	25	6	2.5	0.15	-	-	> 35

bal = balance

\*PREN = %Cr + 3.3%Mo + 16%N

**TABLE 2 Minimum mechanical properties of some common stainless steels**

<b>FORM</b>	<b>ALLOY</b>	<b>0.2% PROOF STRESS (MPa)</b>	<b>UTS (MPa)</b>	<b>ELONGN. (%)</b>
<b>Wrought</b>	<b>Z100</b>	<b>550</b>	<b>750</b>	<b>25</b>
	<b>6Mo Aust.</b>	<b>300</b>	<b>650</b>	<b>35</b>
	<b>22Cr Duplex</b>	<b>450</b>	<b>620</b>	<b>25</b>
	<b>316L</b>	<b>213</b>	<b>500</b>	<b>45</b>
<b>Cast</b>	<b>Z100</b>	<b>450</b>	<b>700</b>	<b>25</b>
	<b>25Cr Duplex</b>	<b>450</b>	<b>650</b>	<b>25</b>

# TABLE 3 Critical crevice temperature for some stainless steels in a simulated anthracite FGD slurry at pH4

Slurry composition:

CaSO <sub>4</sub>	10 wt. %
Chloride	40 g/l
Fluoride	50 mg/l
"Dithionate"	200 mg/l
Fe <sup>3+</sup>	10 mg/l
Al <sup>3+</sup>	30 mg/l

FORM	Alloy	CCT (°C)
Wrought	Z100	> 80
	6Mo aust	64.7
Welded*	Z100	58.5
Cast	Z100	57.8
	25Cr Duplex	42.0

\* Critical Pitting Temperature

# TABLE 4 Critical crevice temperature for some stainless steels in a simulated lignite FGD slurry at pH4

Slurry composition:

CaSO4	10 wt. %
Chloride	15 g/l
Fluoride	200 mg/l
"Dithionate"	200 mg/l
Fe3 +	10 mg/l
Al3 +	30 mg/l

FORM	Alloy	CCT (°C)
Wrought	Z100	>83
	6Mo aust	66.7
Welded*	Z100	63.4
Cast	Z100	62.6
	25Cr Duplex	39.6

\* Critical Pitting Temperature

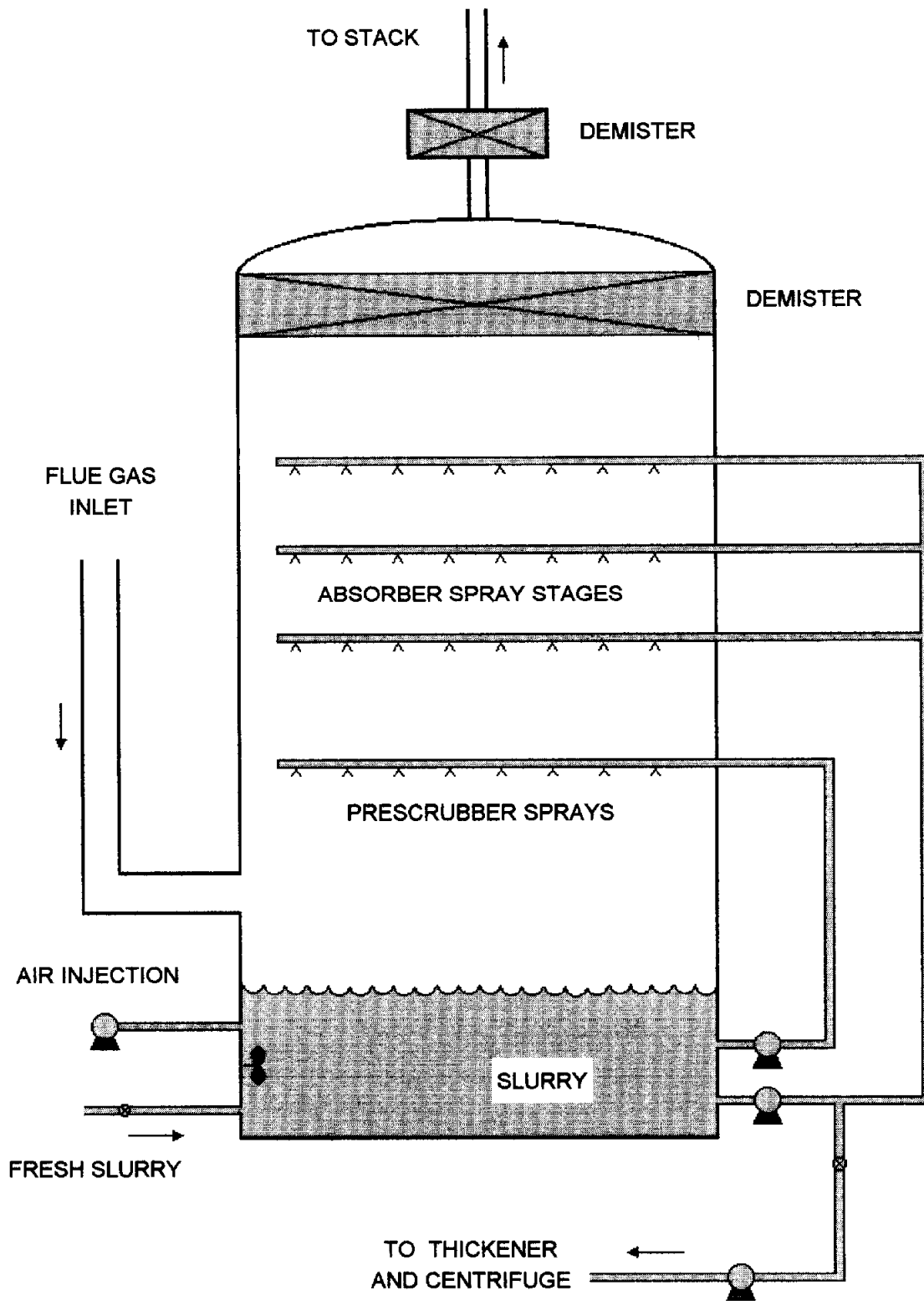

**FIGURE 1.** Schematic diagram of a typical FGD absorber tower (Babcock design).

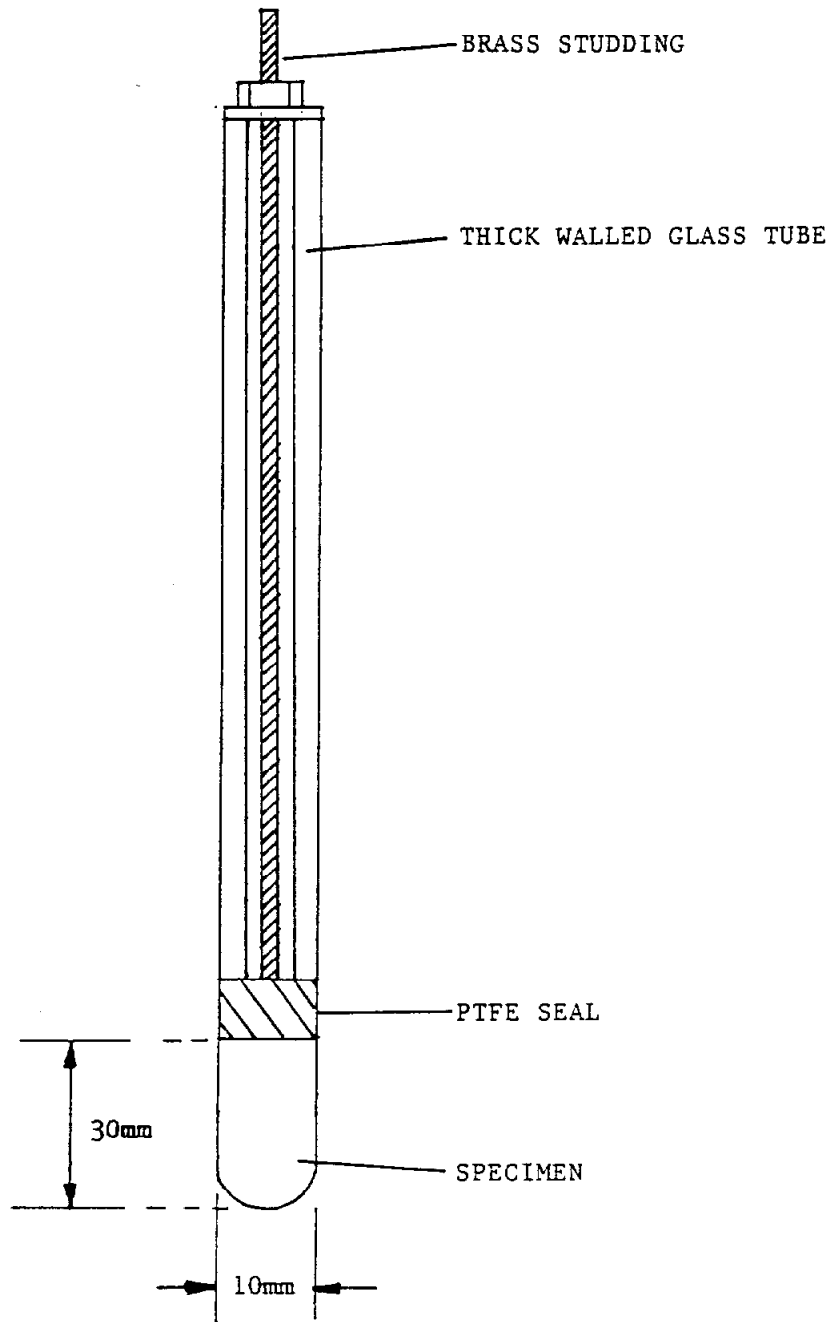

**Figure 2** Specimen and mounting arrangement (not to scale)  
[‘O’ ring omitted]



# FIGURE 3 Rapid rise potential/time curve for super duplex in FGD slurry

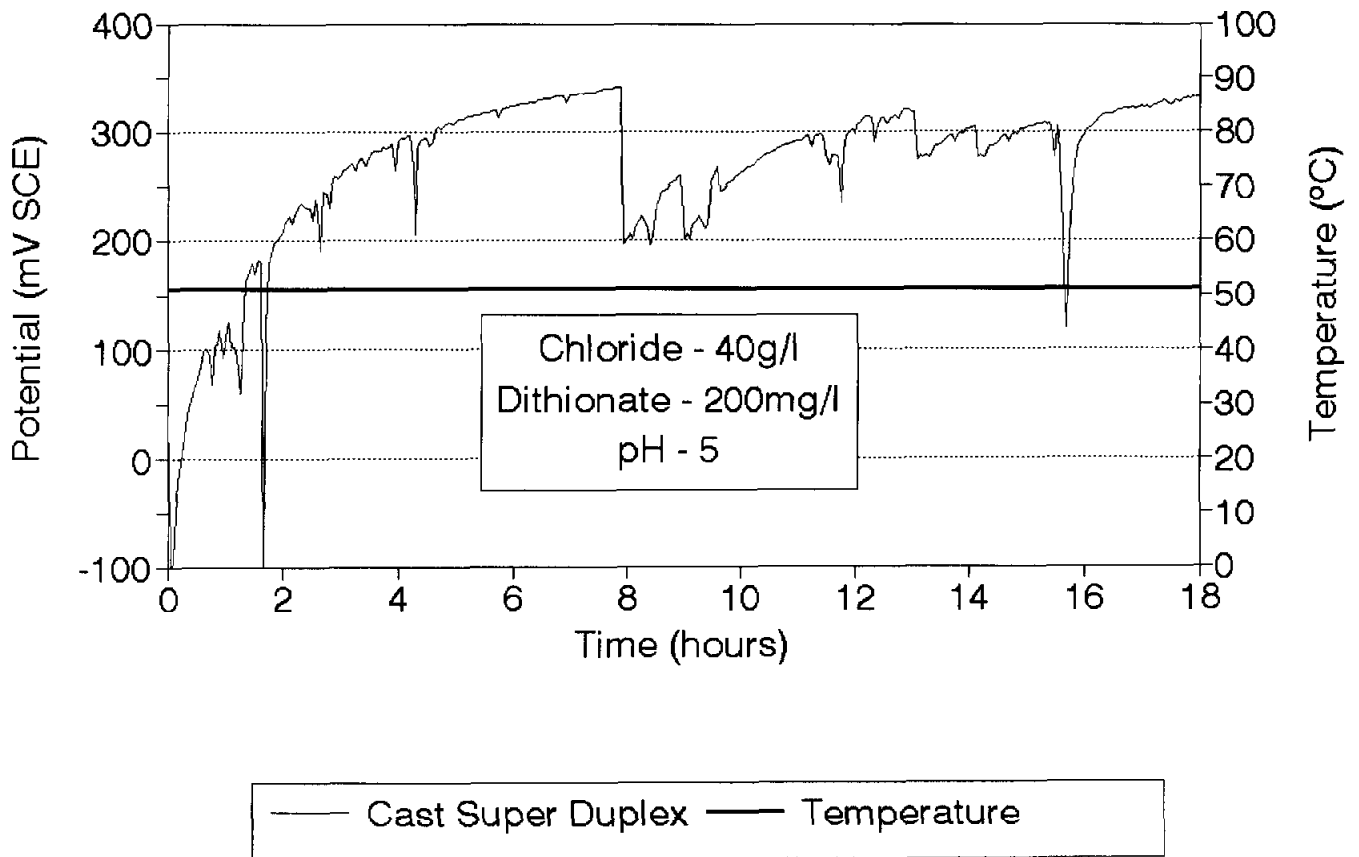

# FIGURE 4 Slow rise potential/time curve for super duplex in FGD slurry

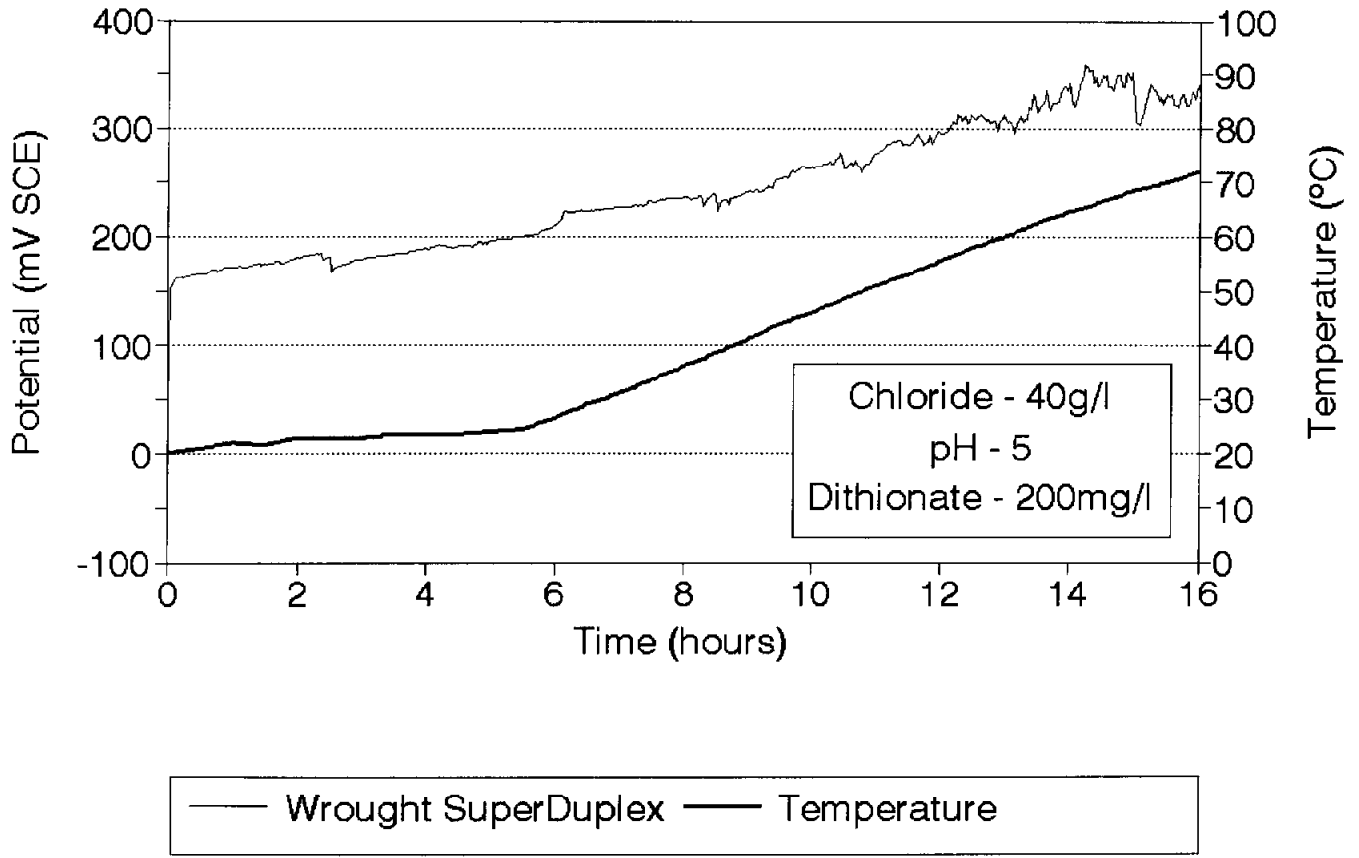

FIGURE 5 Typical current density/time curve at 300mV SCE in FGD slurry

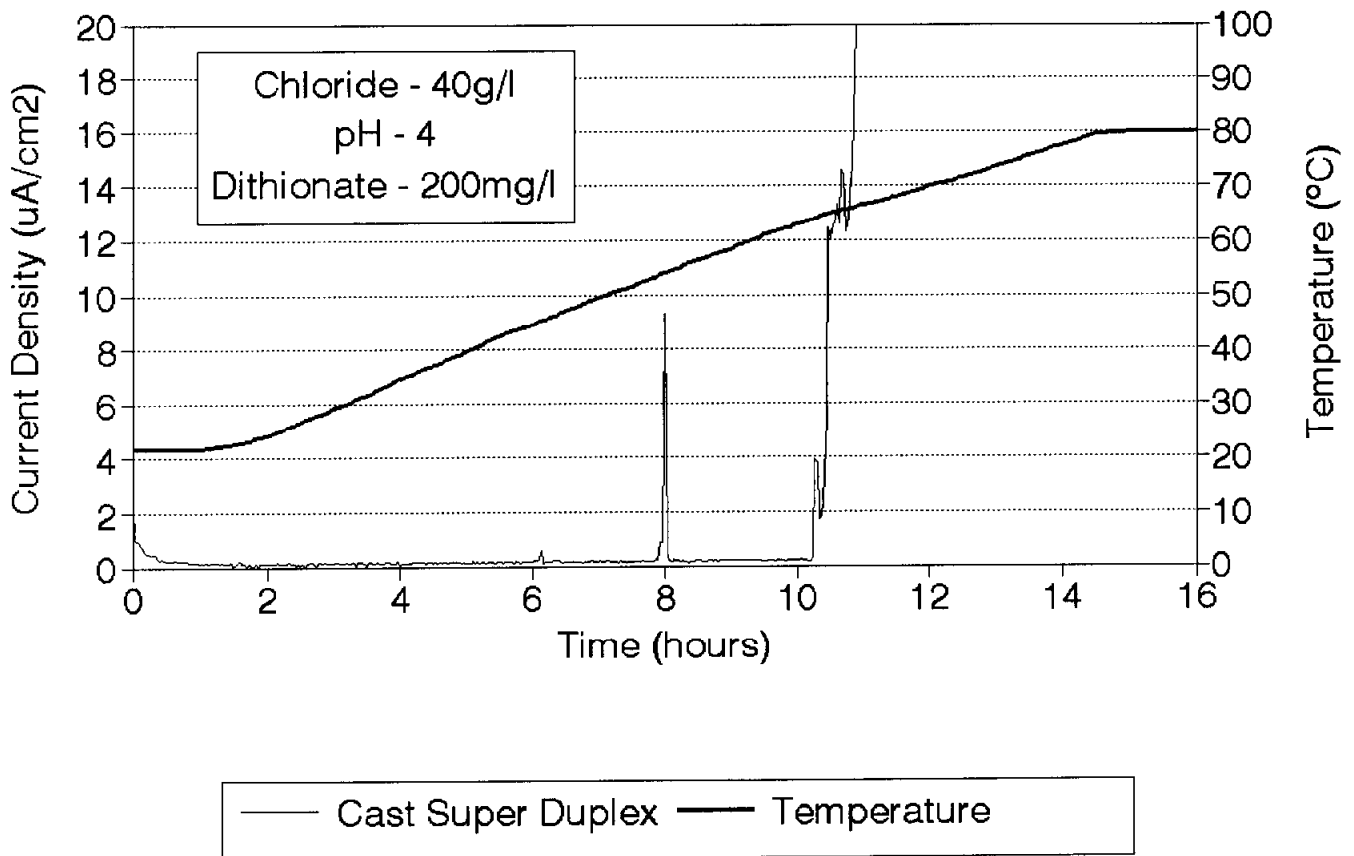

FIGURE 6 Effect of pH on the CCT for for cast super duplex in FGD slurry

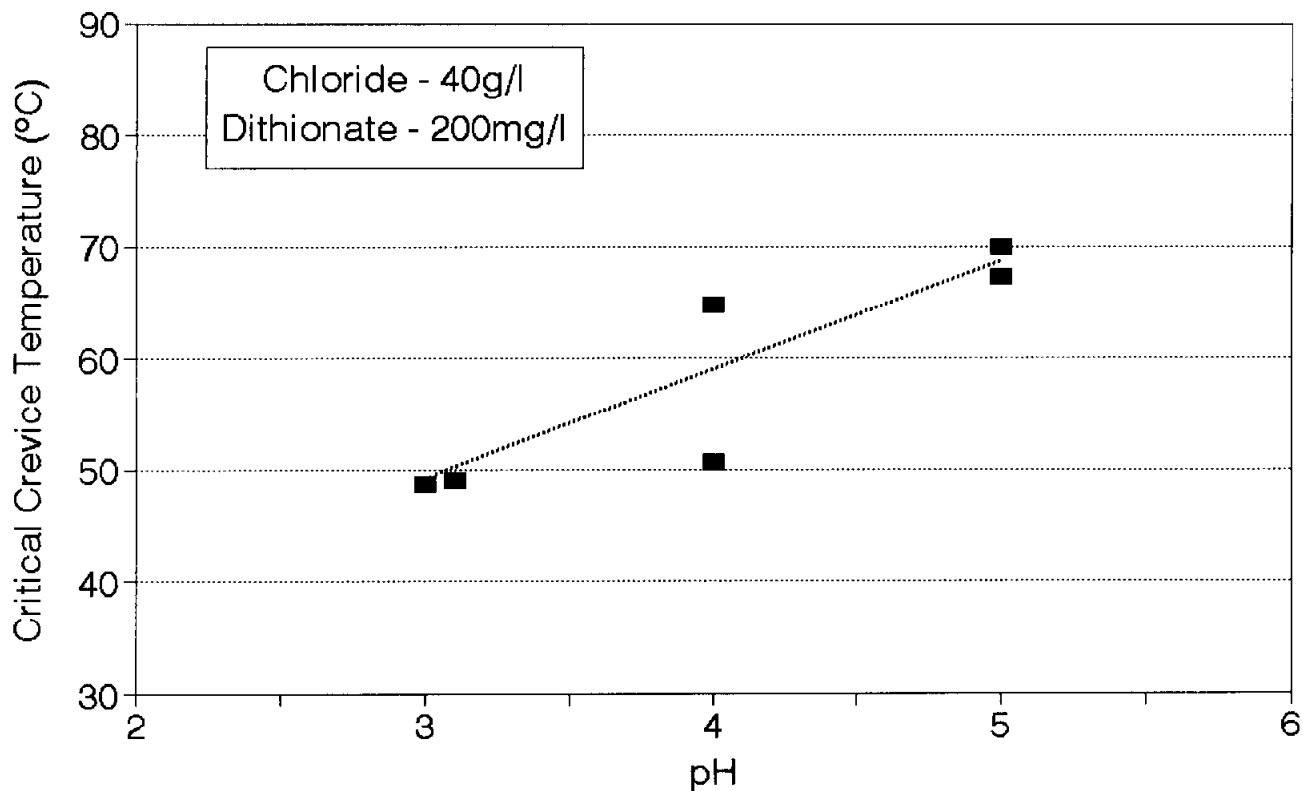
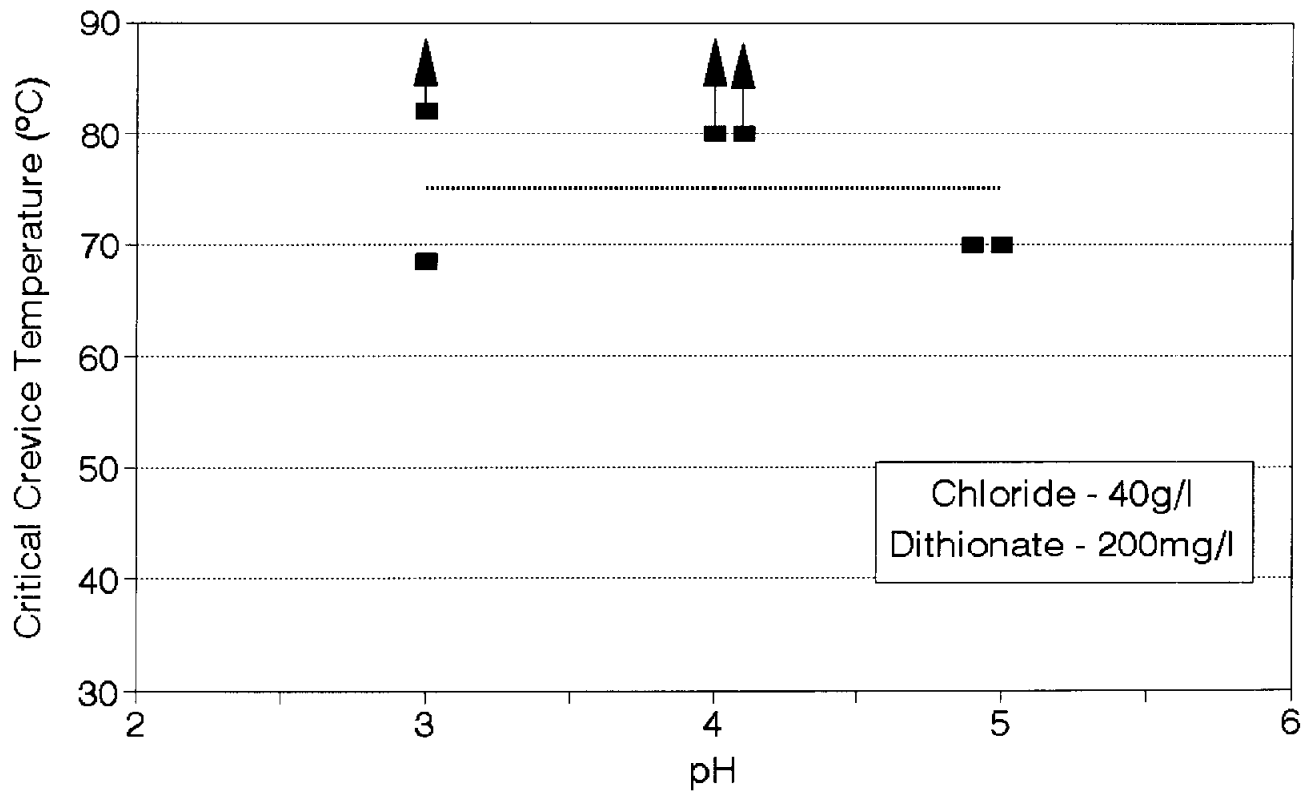

FIGURE 7 Effect of pH on the CCT for wrought super duplex in FGD slurry



# FIGURE 8 Pin erosion test results in a simulated FGD slurry (Ref 5)

